

Instruction Manual

Pressure Relief Valve PV 710

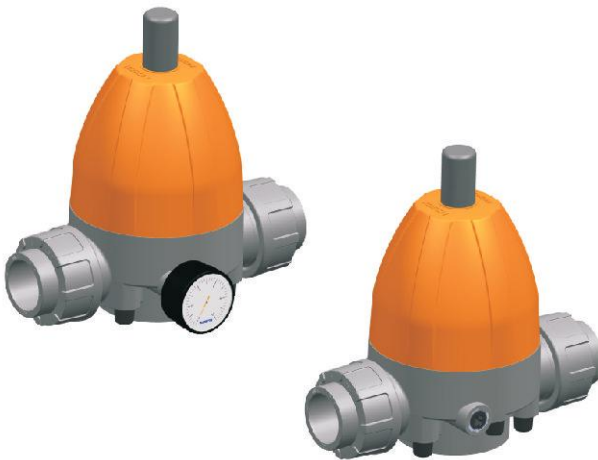

Content

- 1 Regarding this document 02
- 2 Intended use 03
- 3 Safety and responsibility 03
- 4 Transport and storage 05
- 5 Design and function 06
- 6 Technical Data 08
- 7 Installation 09
- 8 Initial operation 11
- 9 Maintenance 12
- 10 Troubleshooting list 13
- 11 List of spare parts 14
- 12 Disposal 15

Original instruction manual

Observe instruction manual



The instruction manual is part of the product and an important element within the safety concept.

- ▶ Read and observe instruction manual.
- ▶ Always have instruction manual available at the product.
- ▶ Pass on instruction manual to all subsequent users of the product.



1 Regarding this document

1.1 Warning notices

This instruction manual contains warning notices that shall prevent you from death, injuries or material damages. Always read and observe these warning notices!

Warning symbol	Meaning
 DANGER	Imminent danger! Failure to observe these warnings could result in death or very serious injuries. Measurements to avoid the danger.
 WARNING	Possible imminent danger! Failure to observe these warnings could result in very serious injuries. Measurements to avoid the danger.
 CAUTION	Dangerous situation! Failure to observe these warnings could result in small injuries. Measurements to avoid the danger.
NOTE	Dangerous situation! Failure to observe these warnings could result in material damages. Measurements to avoid the danger.

1.2 Further symbols and labels

	Notes: Especially important information for comprehension included.
	Call for action: Here, you have to do something.
	Call for action in a certain order: Here, you have to do something.

1.3 Related documents

KOSCN industry

These documents can be obtained from www.koscn.cn

2 Intended use

- Exclusively use the fitting as pressure-relief or overflow valve in pipes for appropriate media.
- Use fitting for solids-free media.

3 Safety and responsibility

The manufacturer accepts no liability for damages caused by disregarding any of the documentation.

3.1 General safety instructions

-  Read and observe the following regulations before carrying out any work.

3.1.1 Obligations of the operating company

- Only operate the fitting if it is in perfect technical condition and only use it as intended, staying aware of safety and risks, and in adherence to the instructions in this manual.

- Ensure that the following safety aspects are observed and monitored:
 - ▶ Intended use.
 - ▶ Statutory or other safety and accident-prevention regulations.
 - ▶ Safety regulations governing the handling of hazardous substances.
 - ▶ Applicable standards and guidelines in the country.
- Make sure all personnel tasked with work on the fitting have read and understood this manual and all other applicable documents, especially the safety, maintenance and repair information, before they start any work.
- Organize responsibilities, areas of competence and the supervision of personnel.
- The following work should be carried out by specialist technicians only.
 - ▶ Installation, repair and maintenance work.
 - ▶ Make sure that trainee personnel only work on the fitting under supervision of specialist technicians.

3.1.2 Obligations of personnel

- Observe the instructions on the fitting and keep them legible, e.g.nameplate, identification marking for fluid connections.
- Only carry out work on the fitting if the following requirements are met:
 - ▶ System is empty
 - ▶ System has been flushed
 - ▶ System is depressurized
 - ▶ System has cooled down
 - ▶ System is secured against being switched back on again

3.2 Hazardous media

- When handling hazardous media (e.g. hot, flammable,explosive, toxic, hazardous to health or the environment),observe the safety regulations for the handling of hazardous substances.
- Use personal protective equipment when carrying out any work on the fitting.
- Collect leaking pumped liquid and residues in a safe manner and dispose of in accordance with environmental regulations.

4 Transport and storage

The product has to be treated, transported and stocked carefully.

Follow the instructions below:

- ▶ Protect the product against external force during transport (impact, stroke, vibrations).
- ▶ Transport and/or store product in its original packaging.
- ▶ Make sure that the product cannot be damaged neither by mechanical nor by chemical impacts.
- ▶ Check the product prior to assembly on transport damages.
- ▶ Protect the product from dust, dirt, moisture as well as heat and ultraviolet radiation.
- ▶ Especially the connections have to be protected against mechanical and chemical impacts.

5 Design and function

5.1 Design

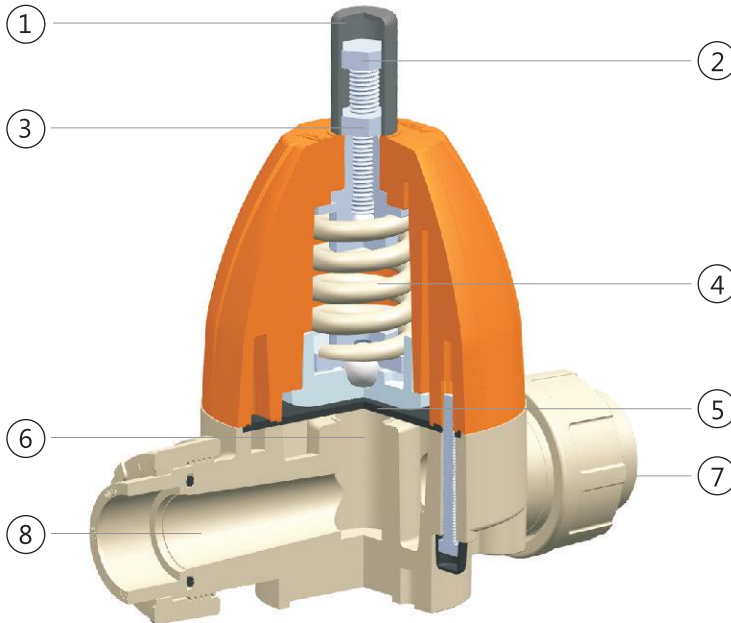

Legend

Pos.	Name	Pos.	Name
1	Protection cap	5	Diaphragm
2	Adjustment screw	6	Valve seat
3	Counter nut	7	Inlet
4	Spring assembly	8	Export

5.2 Diaphragm Valve Type plate

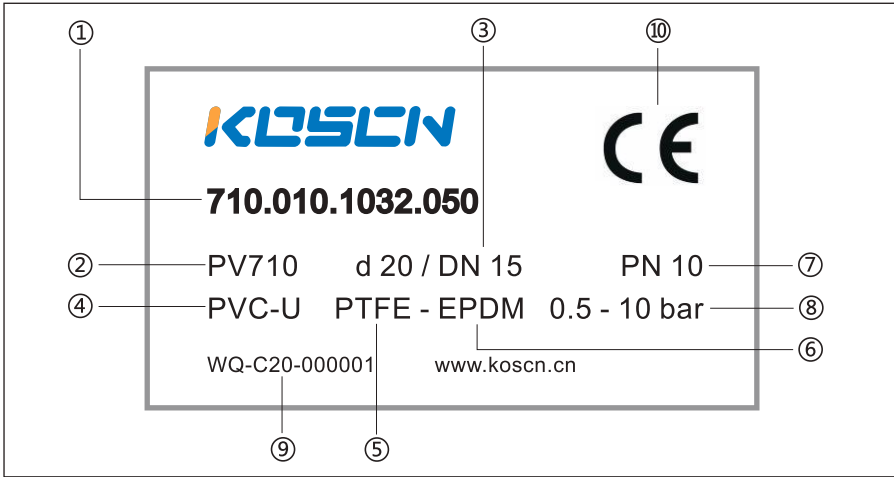

Pos.	Name	Pos.	Name
1	Code number	6	O-ring material
2	Type	7	Pressure Rating
3	Dimension	8	Setting range
4	Valve body material	9	Serial number
5	Diaphragm material	10	CE-Marking

5.3 Direction of flow

 The direction of flow can be identified by the arrow on the fitting.

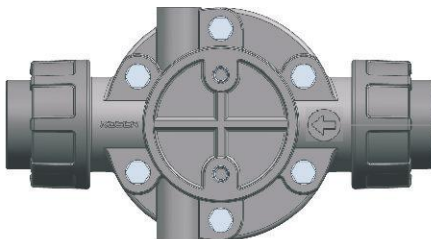

Fitting with directional arrow

6 Technical Data

The curves below are valid for the set range 0.5- 10.0 bar and show the secondary or outlet pressure P2 over the flow Q in l/h. Parameter is the set pressure pE at Q = 0 l/h. There curves are valid for water at +20°C for a flow velocity of 2 m/s.

DN 10

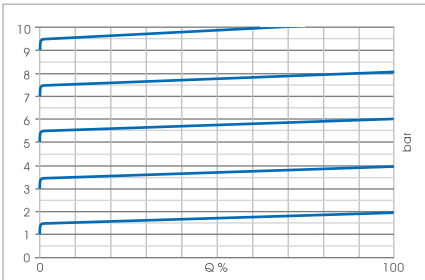

DN 15

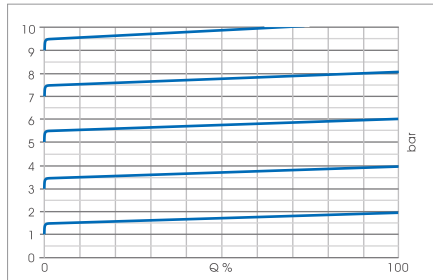

DN 20

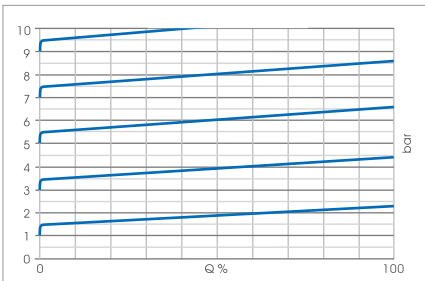

DN 25

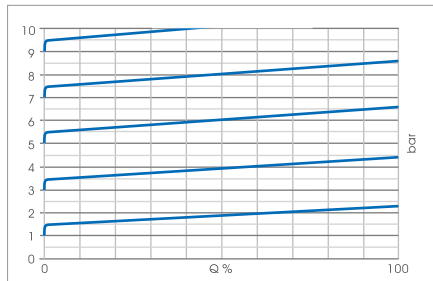

DN 32

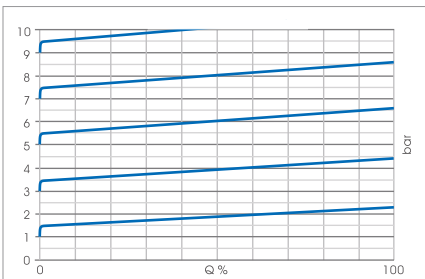

DN 40-50

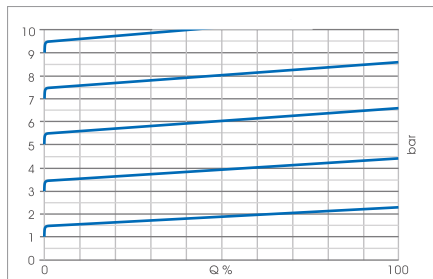

7 Installation

7.1 Preparing for installation

Check operating conditions.

- ▶ Ensure the design of the fitting is consistent with the purpose intended.
- ▶ Ensure the required operating conditions are met.
 - Resistance of body and seal material to the medium
 - Media temperature
 - Working pressure
 - Setting range

Consult with the KOSCN regarding any other use of the device.

7.2 Installation

- ▶ Plan pipes safely: No pulling, thrusting forces or No bending moments
- ▶ Pressure test using neutral medium: Test pressure \leq permissible system max pressure
- ▶ Check the fitting for leaks.



- ▶ Risk of poisoning and environmental damage from medium.
- ▶ Leaks due to impermissible pipework forces.
- ▶ Ensure that the fitting is not subject to any pulling or thrusting forces or bending moments.
- ▶ Leak due to faulty installation.
- ▶ Installation work on the pipes should only be performed by technicians who have been specially trained for the pipework in question.

NOTICE

Material damage due to contamination of the fitting!

- ▶ Make sure no contamination reaches the fitting.
- ▶ Flush the pipe with a neutral medium.

7.3 Installation examples

Pressure relief to ensure system safety

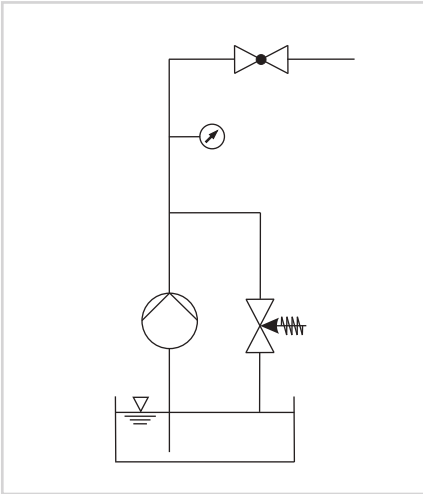

Use at high inlet pressure or
Generation of a constant working pressure

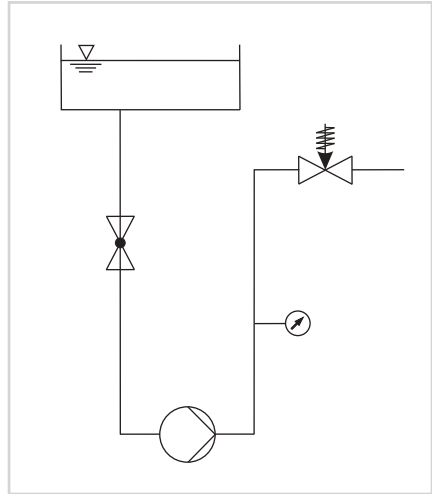

Optimal solution for the reduction of pressure surges with overflow valve to protect the system

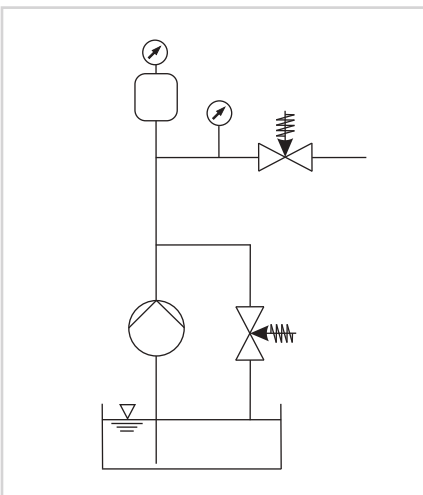

8 Initial operation

8.1 Set pressure



Presetting from factory: 0.5 bar. Other presetting possible upon consultation with KOSCN.

- Set the pressure relief valve under the same conditions encountered later during operation!
- Recommendation for the setting: Installation of a filter before the pressure relief valve.

Schematic representation.

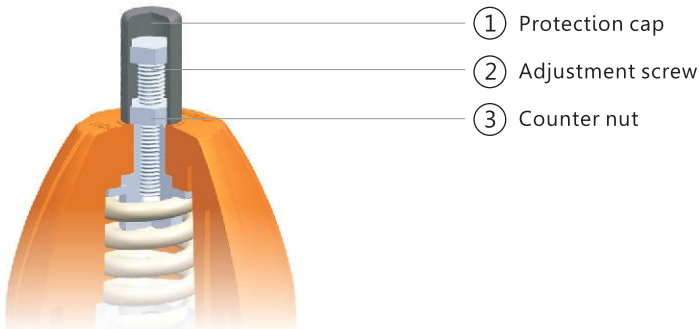

1. remove protection cap (1) at adjustment screw(2) from the valve.
2. Undo locknut (3).
3. Turn adjustment screw (2) counter-clockwise until the pressure spring is perceptibly completely relieved of tension.
Valve is open.
4. Start up system.
5. Turn adjustment screw (2) clockwise until desired system pressure is reached.
6. Fix the adjustment screw (2) using a ring wrench, then tighten the locknut (3).
7. Plug on protection cap (1)

8.2 Commissioning



Fitting correctly installed and connected, Risk of injury and poisoning due to medium spraying out.

- ▶ Use personal protective equipment when carrying out any work on the fitting.
- ▶ After the initial stresses due to pressure and operating temperature, check if the fitting is sealed.

9 Maintenance



Risk of injury and poisoning due to hazardous media liquids!

- ▶ Use personal protective equipment when carrying out any work on the fitting.

9.1 Servicing

Visual and function check:

- Normal operating conditions unchanged
- No leaks
- No unusual operating noises or vibrations

9.2 Removing fitting

- ▶ Ensure that:
 - System is empty
 - System has cooled down
 - System is secured against being switched back on again
- ▶ Remove fitting from the pipe.
- ▶ Decontaminate fitting if required.



Risk of injury and poisoning due to hazardous or hot media.

- ▶ Use personal protective equipment when carrying out any work on the fitting.
- ▶ Safely collect the media and dispose of it in accordance with environmental regulations

Risk of injury during disassembly!

- ▶ Wear protective gloves, components can be very sharp edged due to wear or damage.
- ▶ Remove components with springs carefully, since spring tension can cause components to be ejected.

9.3 Replacement parts and return

Have the nameplate information ready to hand when ordering spare parts.

For ordering spare parts or returns, Please contact koscn or distributor (www.koscn.cn).

10 Troubleshooting list



Risk of injury and poisoning due to hazardous or hot media.

- ▶ Use personal protective equipment when carrying out any work on the fitting.
- ▶ Safely collect the media and dispose of it in accordance with environmental regulations.

Problem	Possible cause of fault	Problem fixing
Pressure falls below the permissible value	Diaphragms leaky	▶ Replace Diaphragm
	Valve seat leaking	▶ Check valve seat
Pressure rises above permissible value	Wrong installation direction	▶ Install fitting in correction direction
Leaky at diaphragm	Loose connection of nut and valve body	▶ Retighten screws
Medium leaks out at adjustment screw	Diaphragm damage	▶ Replace Diaphragm

Consult with the KOSCN regarding faults which are not identified in the following table, or which cannot be traced to the indicated causes.

11 List of spare parts

Pos.	Name	Pos.	Name
01	Protection cap	09	Steel ball
02	Adjustment screw	10	Compressor
03	Counter nut	11	Diaphragm
04	Upper part	12	valve body
05	Steel ball	13	Union end
06	Pressure plate	14	Union nut
07	spring	15	O-ring
08	Spring plate	16	Housing screw

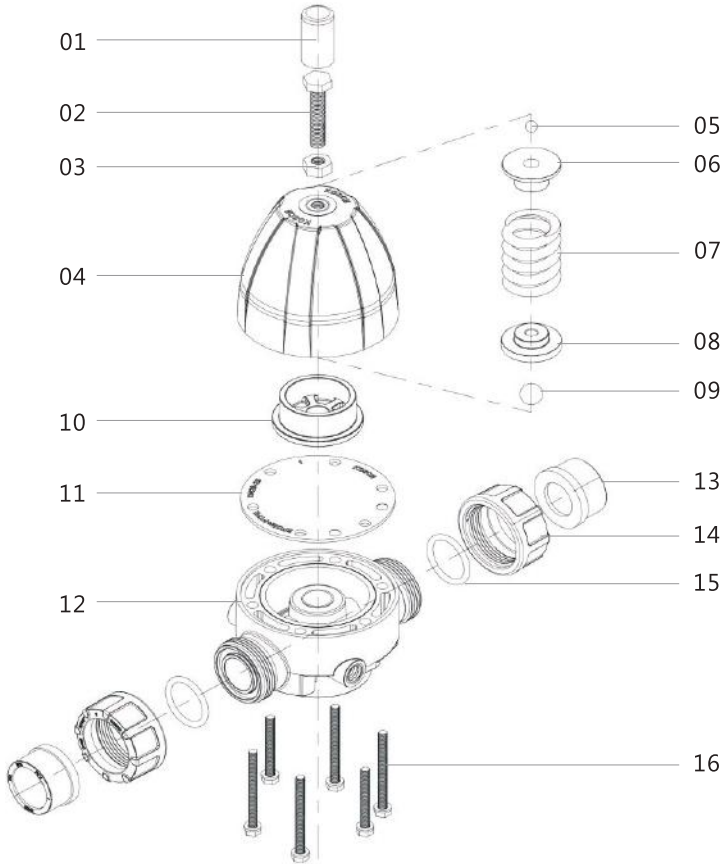

12 Disposal



Before disposing of the product:

- ▶ Collect any spilled media and dispose of according to the local regulations. Refer to the safety data sheet.
- ▶ Neutralise any media residues remaining in the product.
- ▶ Separate the materials (plastics, metals etc.) and dispose of them according to local regulations.